

# FREE CHLORINE RESIDUAL IMPROVEMENT IN THE PARKES SHIRE COUNCIL B-SECTION

**Lucy Parsons**, *Chemical Engineer*, Atom Consulting

## ABSTRACT

Atom Consulting has recently completed a project to improve system understanding and water quality for the Parkes Shire Council's B-Section pipeline. The 148 km B-Section pipeline receives water from Forbes Shire Council and feeds water to Lachlan Shire Council, serving 675 connections. It had been identified as being at risk of backflow from commercial customers and low free chlorine.

A P&ID of the pipeline and EPANET hydraulic model were developed to document operator knowledge. A chlorine decay study was undertaken in the Parkes WTP with the B-Section water to understand the rate of chlorine decay. The results from this were incorporated into the hydraulic model so it could be used for water quality also.

The model was used to determine the optimal chlorine dose rate at the new Forbes rechlorinator and adjust the dose rate at the downstream Trundle rechlorinator. It was also used to investigate how changing reservoir level improved water quality and the effect of summer and winter demand patterns on water age and quality. Operations and management staff were trained in the use of the model for their own further investigation.

When the rechlorinator was installed, a commissioning risk assessment was undertaken to address the unique risks associated with introducing the new rechlorinator such as biofilm sloughing.

The project resulted in a better understanding of how the B-Section operates and improved free chlorine residual throughout the system.

## 1.0 INTRODUCTION

Parkes Shire Council (PSC) supplies potable water to residents through two distribution networks:

- Parkes-Peak Hill Scheme (5,867 connections)
- B-Section Scheme (675 connections)

PSC owns and operates a 148 km section of the B-Section pipeline which is fed with potable water from Forbes Shire Council's (FSC) Water Treatment Plant (WTP). PSC operates the pipeline from the outlet of Turner's Hill Reservoir (located within the Forbes township), to the PSC/Lachlan Shire Council (LSC) boundary, north of Tullamore. LSC owns and operates the pipeline from this boundary through to Albert reservoir and then to Tottenham. The average demand of the system is 613 kL/day.

## 2014-18 B-section verification free chlorine (mg/L)

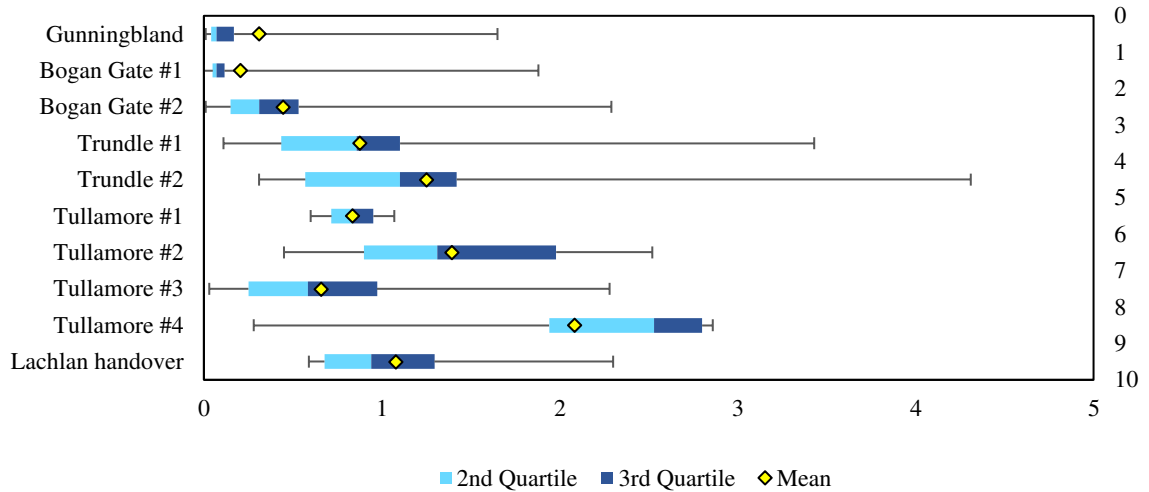

**Figure 1** Parkes B-Section NSW Health verification free chlorine results

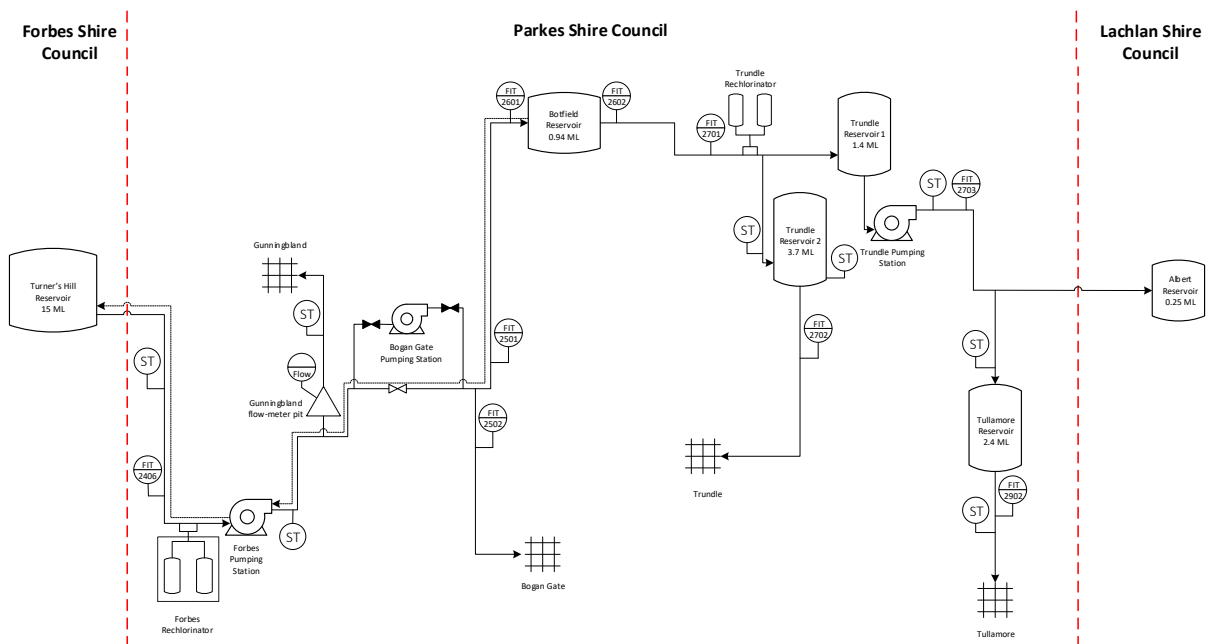

**Figure 2** Parkes B-Section Process Flow Diagram

The B-Section has previously been flagged as at risk of backflow from rural customers and there is limited data available regarding the historical free chlorine residual. NSW Health verification data from 2014 to 2018 is in Figure 1.

The handover point at Turner's Hill Reservoir is consistently supplied with a free chlorine residual below 0.5 mg/L. Previously the system was only rechlorinated at Trundle which left PSC without control of the free chlorine residual on the first half of the B-Section in Trundle. PSC was planning to install a new rechlorinator at the handover point from Forbes Shire Council to improve water quality. Figure 2 is a diagram of the B-Section system with the location of the new Forbes rechlorinator marked.

The purpose of this project was to answer the following research questions:

- How rapidly does contamination move through the B-Section?
- What is the optimum dose rate for the Forbes rechlorinator?

- What should the trundle dose rate be set at once the Forbes rechlorinator is operational?
- What is the time lag between the Forbes and Trundle rechlorinator?
- Can the dosing location at Trundle be optimised to improve chlorine residual throughout the system?
- Are there areas where free chlorine residuals will remain low?
- Can water age be optimised?
- Does the model show negative pressures in the pipeline?

The project was separated into the following stages:

1. Piping and instrumentation diagram development and ground truthing
2. Chlorine decay study
3. EPANET model development
4. Optimisation of chlorine residual
  - a. Set Trundle and Forbes rechlorinator dose rate
  - b. Changing reservoir level to improve water age
  - c. Summer/winter demand impact on water age
  - d. Reservoir arrangement
5. Staff EPANET model training
6. Forbes rechlorinator commissioning risk assessment

## **2.0 DISCUSSION**

### **2.1 P&IDs**

To develop an accurate hydraulic model in EPANET, the arrangements at key sites in the network had to be properly understood. The B-Section was inherited and documentation about how the system operates was difficult to locate. Due to the limited availability of data and records on the B-Section, new P&IDs were developed.

The drawings were informed by visual inspection and on-site observations, and verified using operator knowledge and GIS maps. Existing draft P&IDs were used to aid understanding from visual observations and the numbering of valves where tags had faded or were missing. Field verification noted that these drafts were limited and inaccurate in parts when compared to on-site observations and these errors were corrected in the updated P&IDs prepared during the project.

### **2.2 Chlorine Decay Study**

Six water samples were taken from the Forbes Pump Station after flushing and were stored in a stable environment minimising exposure to light and temperature change.

The samples were separated into three pairs and dosed with sodium hypochlorite to a free chlorine concentration of 1 mg/L, 3 mg/L and 5 mg/L respectively, one sample from each pair being reserved for later testing. Samples were taken and tested continuously for the first few hours then decreased to every 15 minutes, then to hourly.

The remaining three samples were stored for 7 days and 4 hours to simulate the water transit time from Forbes Pump Station to the Trundle rechlorination point. After this period, they were redosed with sodium hypochlorite to a free chlorine concentration of 1 mg/L, 3 mg/L and 5 mg/L respectively. Samples were taken for testing regularly until the chlorine stabilised, in the same manner as the initial testing.

The results from the decay testing were plotted and used to determine a bulk decay coefficient for both rechlorination stages. See Figure 3 for the results of the first stage of testing and the decay curves.

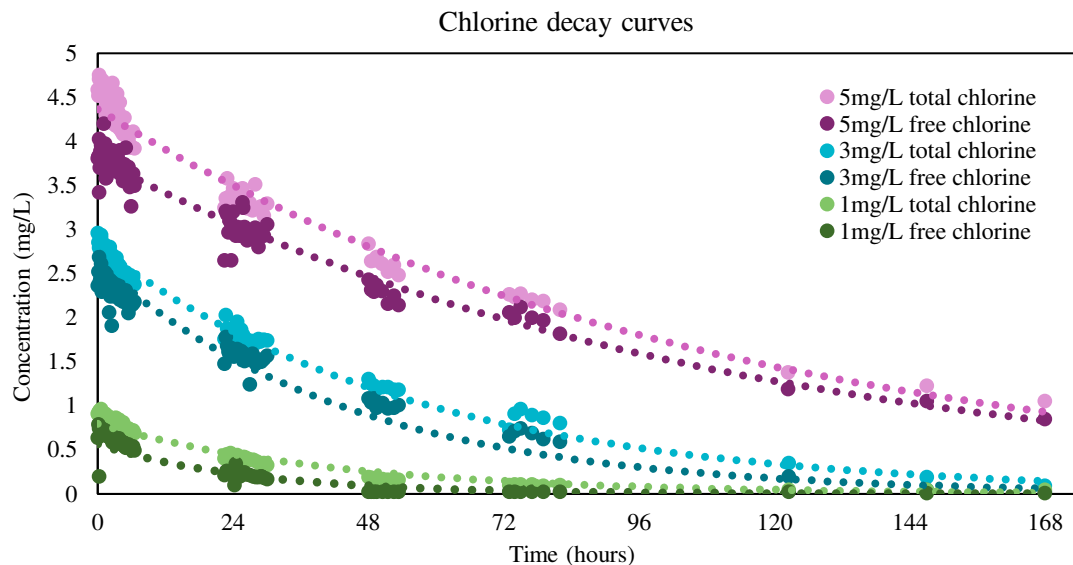

**Figure 3** *Chlorine decay curve for the Forbes rechlorinator*

The bulk decay coefficients for free chlorine at the two chlorination points were obtained for each of the concentrations. The curve of best-fit was the 5 mg/L dosed free chlorine curve, since it had the highest  $R^2$  value of 0.97. The equation of the curve was found to be:

$$C = 3.8074e^{-0.218t}$$

C = chlorine concentration mg/L

t = time (days; Rossman, 2000)

This value and the results from the Trundle rechlorinator decay curve were inputted into the EPANET model.

### 2.3 EPANET model development and optimisation of chlorine residual

EPANET 2.0 was developed by the US EPA in 2008 as a software to model water distribution systems. It performs extended period simulations of hydraulic and water quality behaviour within pressurised pipe networks. The networks can include pipes, nodes, pumps, valves, storage tanks and reservoirs as well as rechlorinators. The equipment from the P&IDs, bulk decay coefficients from the chlorine decay study, GIS data and hydraulic information collected from operators were input into models for analysis.

The model was used to analyse the flow of a contaminant into the system, determine pressure through the system and determine the optimum dose rate for the Forbes and Trundle rechlorinators, assess any need for dose changes in summer or winter. Examples of the Forbes and Trundle rechlorinator models are shown in Table 1 and Table 2. The colour scale used in these diagrams is shown to the right.

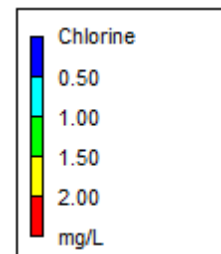

**Table 1** *Forbes dose rate*

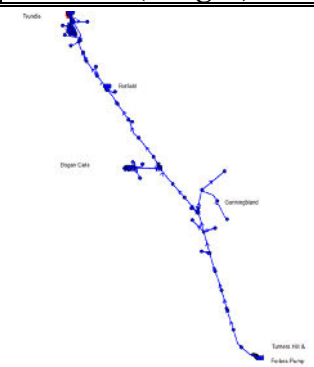
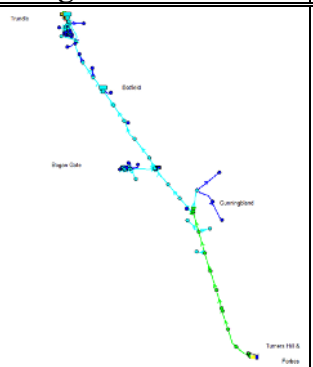
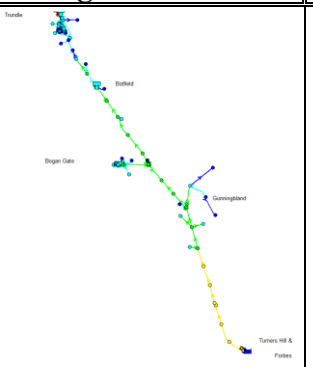
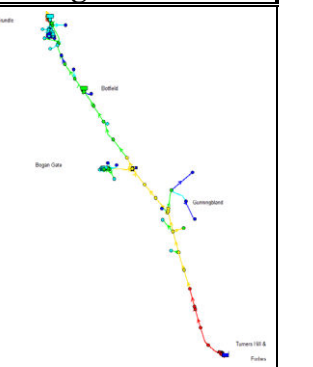
Baseline (0 mg/L)	1 mg/L	1.5 mg/L	2.0 mg/L
			
Trundle between 0.1-0.2 mg/L	Trundle between 0.45-0.7 mg/L	Trundle between 0.6-1.0 mg/L	Trundle between 0.8-1.3 mg/L

**Table 2** *Trundle dose rate*

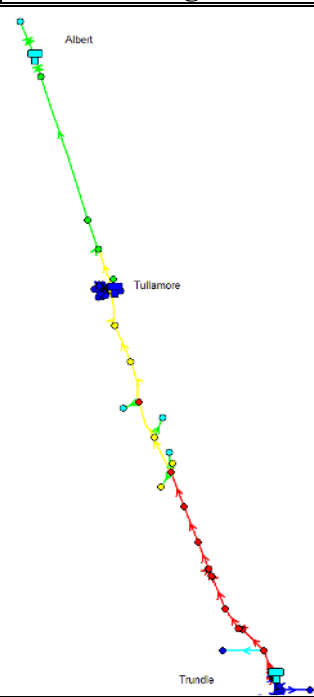
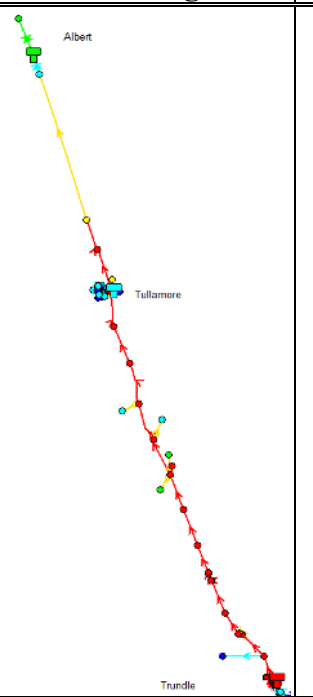
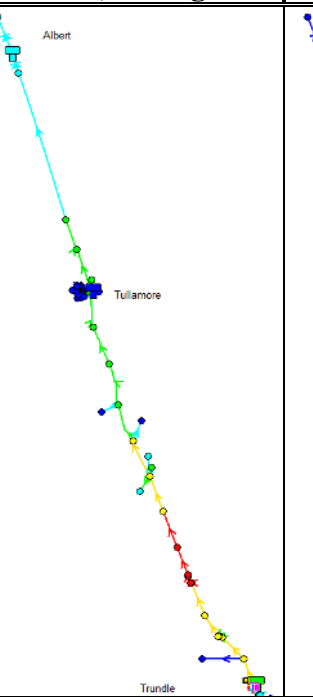
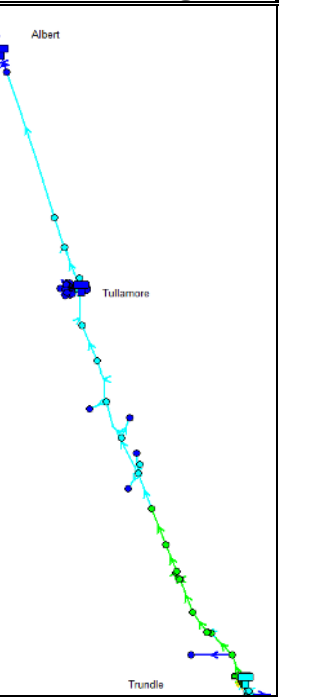
Baseline dose rate: Forbes 0 mg/L, Trundle 4 mg/L	Dose rate: Forbes 1.0 mg/L, Trundle 4 mg/L	Dose rate: Forbes 1.0 mg/L, Trundle, 2.0 mg/L	Dose rate: Forbes 1.0 mg/L, Trundle, 1.0 mg/L
			
Albert reservoir: 0.5-0.7 mg/L, Tullamore: 0.3-0.4 mg/L	Albert reservoir: 0.7-1.9 mg/L, Tullamore: 0.6-0.7 mg/L	Albert reservoir: 0.5-1.1 mg/L, Tullamore reticulation: 0.3-0.5 mg/L	Albert reservoir: 0.3-0.6 mg/L, Tullamore reticulation: 0.2-0.3 mg/L

Another outcome of the model was the recommendation for the use of motorised valves to reduce reservoir height including the investigation into how this will affect pressure in town. The reservoir refill time from empty for Trundle Reservoir 1 and 2 and Tullamore reservoir was modelled and found to be 130 hours, 550 hours and 60 hours respectively.

Parkes operations staff and management staff were trained in how to use the model for their own further investigation to allow them to model configuration changes.

## 2.5 Forbes rechlorinator commissioning risk assessment

Once the Forbes rechlorinator was installed, a risk assessment workshop was held that was based on HAZOP to assess the possible issues that could arise during commissioning. There was a particular concern regarding the introduction of free chlorine residual to a previously low area causing sloughing of biofilm from the pipes. The workshop resulted in increased preparedness and a number of actions that could be implemented before or immediately after the commissioning to minimise risk. Water quality was monitored closely during the period when the chlorine dose was being increased.

### **3.0 CONCLUSION**

This modelling and risk assessment the free chlorine residual in the B-Section has stabilised. Operations staff have improved understanding of how the system operates under standard conditions and reacts to changing conditions. This understanding has been documented in a report and in an EPANET model that the staff can to continue their own investigations. Opportunities for system improvement including the use of motorised valves have also been identified.

### **4.0 ACKNOWLEDGEMENTS**

Thank you to the Parkes Shire Council staff who assisted in the collection of information and participated in the scoping, training and risk assessment workshops and the Atom Consulting team for technical advice and support through this project.

### **5.0 REFERENCES**

Atom Consulting, 2018, Parkes-Peak Hill and B-section water supply systems, drinking water quality risk assessment output paper

NHMRC, Australian Drinking Water Guidelines 2011 version 3.5, Australian Government, Canberra, 2019

Rossmann, L. 2000. EPANET 2 User's Manual. U.S. Environmental Protection Agency.  
Schnelle, M, 2016, Characterising Chlorine Decay in the Parkes-Peak Hill Scheme, Thesis, The University of Sydney

Schnelle, P, 2018, Formulating a Backflow Prevention Program for the Parkes Shire Council B-Section Network, Thesis, The University of Sydney

Unites States Environmental Protection Agency (US EPA) 1999, Disinfection Profiling and Benchmarking Guidance Manual, Unites States Environmental Protection Agency (US EPA), USA

Water Group Pty Ltd, 2014, B-Section Water Loss Management Plan, Water Group Pty Ltd, Ryde

Water Research Australia, 2014, Guidance manual for the maintenance of chlorine and chloramine residuals, Project 1064 , Chow, Cook, and Mussard